

PHONIC

WM400-L / WM400D-L

WM400-R / WM400D-R

Wireless Receivers

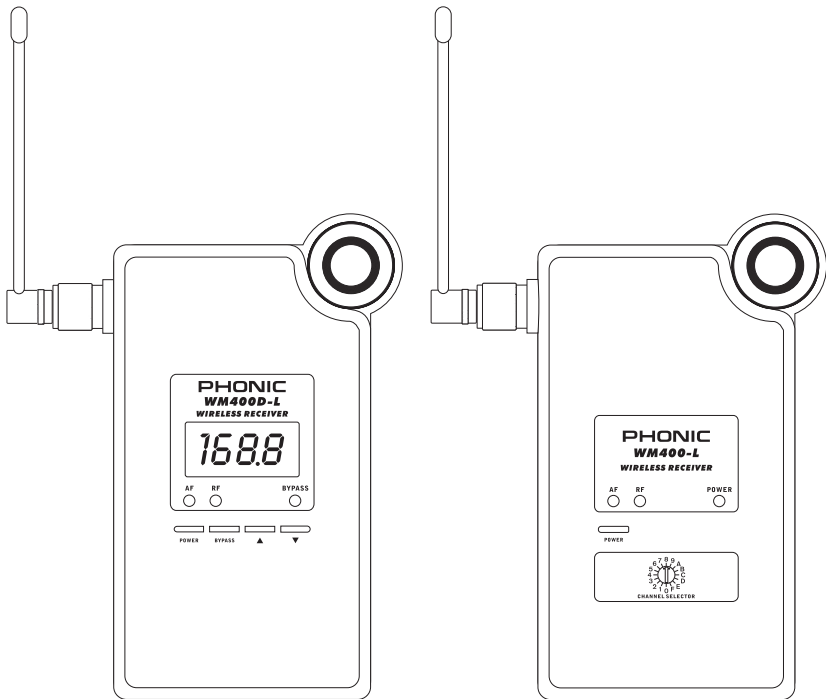

English

User's Manual

IMPORTANT SAFETY INSTRUCTIONS

The apparatus shall not be exposed to dripping or splashing and that no objects filled with liquids, such as vases, shall be placed on the apparatus. The MAINS plug is used as the disconnect device, the disconnect device shall remain readily operable.

Warning: the user shall not place this apparatus in the confined area during the operation so that the mains switch can be easily accessible.

1. Read these instructions before operating this apparatus.
2. Keep these instructions for future reference.
3. Heed all warnings to ensure safe operation.
4. Follow all instructions provided in this document.
5. Do not use this apparatus near water or in locations where condensation may occur.
6. Clean only with dry cloth. Do not use aerosol or liquid cleaners. Unplug this apparatus before cleaning.
7. Do not block any of the ventilation openings. Install in accordance with the manufacturer's instructions.
8. Do not install near any heat sources such as radiators, heat registers, stoves, or other apparatus (including amplifiers) that produce heat.
9. Do not defeat the safety purpose of the polarized or grounding-type plug. A polarized plug has two blades with one wider than the other. A grounding type plug has two blades and a third grounding prong. The wide blade or the third prong is provided for your safety. If the provided plug does not fit into your outlet, consult an electrician for replacement of the obsolete outlet.
10. Protect the power cord from being walked on or pinched particularly at plug, convenience receptacles, and the point where they exit from the apparatus.
11. Only use attachments/accessories specified by the manufacturer.
12. Use only with a cart, stand, tripod, bracket, or table specified by the manufacturer, or sold with the apparatus. When a cart is used, use caution when moving the cart/apparatus combination to avoid injury from tip-over.
13. Unplug this apparatus during lightning storms or when unused for long periods of time.
14. Refer all servicing to qualified service personnel. Servicing is required when the apparatus has been damaged in any way, such as power-supply cord or plug is damaged, liquid has been spilled or objects have fallen into the apparatus, the apparatus has been exposed to rain or moisture, does not operate normally, or has been dropped.

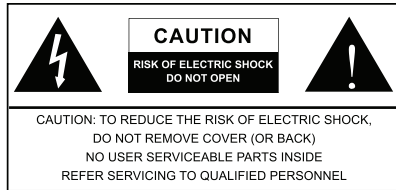

The lightning flash with arrowhead symbol, within an equilateral triangle, is intended to alert the user to the presence of uninsulated "dangerous voltage" within the product's enclosure that may be of sufficient magnitude to constitute a risk of electric shock to persons.



The exclamation point within an equilateral triangle is intended to alert the user to the presence of important operating and maintenance (servicing) instructions in the literature accompanying the appliance.

WARNING: To reduce the risk of fire or electric shock, do not expose this apparatus to rain or moisture.

CAUTION: Use of controls or adjustments or performance of procedures other than those specified may result in hazardous radiation exposure.



WM400-L/WM400D-L WM400-R/WM400D-R Wireless Receivers

USER'S MANUAL

CONTENTS

INTRODUCTION.....	4
FEATURES.....	4
PRODUCT DESCRIPTION.....	5
WM-400(D) POWER MODES.....	7
THE WM400D'S DIGITAL FEATURES.....	8
ATTACHING THE UNIT TO A SPEAKER.....	9
DIMENSIONS.....	10
SPECIFICATIONS.....	11
EQ PRESETS.....	12

INTRODUCTION

Congratulations on your purchase of the WM400(D) wireless receiver, to be used in conjunction with the WM60 or WM70 wireless transmitters. With either the stereo or mono WM kits, you are now fast on your way to becoming completely wireless in your audio set up. The WM modules are not only fantastic in style and convenience, however; they are incredibly easy to use, as this manual will no doubt prove.

Please have a thorough read of this user's manual before operating the WM modules. Inside this guide you will find information on the ease of your wireless set up, as well as some great troubleshooting tips and a complete run-down on your modules' features. After reading, place the manual in an easy to remember place so that you can come back to it in future if ever necessary.

FEATURES

- Working with the WM60 or WM70 transmitter to form a wireless system for saving the audio cables between your mixer and active speakers
- Stand-alone UHF wireless receiver, compatible with WM60 and WM70 transmitters
- 12VDC external power supply (country dependent)
- 16 user-selectable frequencies
- RF carrier frequency range:
614.175 - 804.800 MHz (FCC)
614.175 - 864.800 MHz (CE)
- Operating range: 210 ft. (70m, environment dependent)
- Indicators for power on, AF and RF
- Antenna: external, threaded connector
- Audio output connectors: XLR out
- M6, M8, M10 screws and Velcro strip included for attaching WM400(D) to any speakers

WM400D-L or WM400D-R plus:

- 300 ms digital delay processor for compensation of different distance speakers
- 0.1 millisecond to 300.0 millisecond delay range, delay adjustment may be made with 0.1 millisecond precision
- 30 preset EQ curves and variable high cut and low cut filters
- 4-digit display to indicate frequency channel and delay, plus AF, RF and delay bypass indicators

PRODUCT DESCRIPTION

These wireless receivers can be used in conjunction with any active speaker. The receiver can be attached to the speaker by screwing it into the stand's screw socket.

1. 4 Digit Display

(WM400D-L and WM400D-R only)

This display will allow users to see the properties that are currently in use by the WM400D, whether you are adjusting the receiver channel (indicated by CH), the EQ settings (indicated by EQ), the delay time (indicated by only the delay time in milliseconds) or the high and low pass filters (indicated by a H or L, respectively). When this unit is powered, the 4 digit display will light up.

2. AF Indicators

When this LED is illuminated, it indicates that there is an audio signal being received by the WM400(D) receiver.

3. RF Indicators

When the RF indicator illuminates, it shows that the transmitter's signal is being received successfully. If for some reason this LED does not turn on, check your DC power input and pre-set channel configuration and try again.

4. Bypass Indicator

(WM400D-L and WM400D-R only)

This LED will light up when the digital processing feature of the WM400(D) receiver is off.

5. Power Button

hold this button down for 2 seconds to power up the unit.

6. Bypass Button

(WM400D-L and WM400D-R only)

Push this button to turn the digital processing feature on and off.

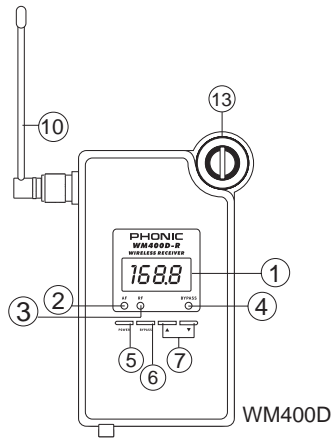
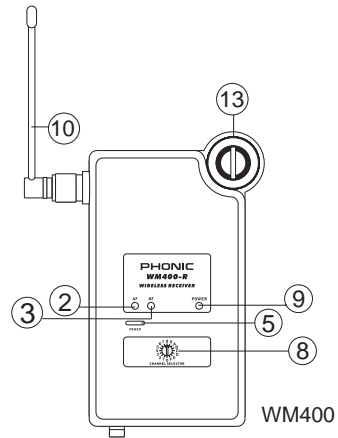

7. Up and Down Buttons

(WM400D-L and WM400D-R only)
 These buttons are used to adjust the properties of various features built-into the WM400D's. Pushing up or down will initially simply allow users to adjust the channel that the transmitter is using. If you push both of these buttons at the same time, it will jump to the next setting that can be edited. You can then adjust the properties by pushing the up and down buttons. These settings will come in the following order:

Channel Settings: CH 0 – CH 9,
 CH A – CH F

Delay Settings: 0.0 – 300.0 milliseconds
EQ Mode: P1 – P30 (see the EQ table for a full rundown on EQ presets)
Low Cut Filter: L 20 (Hz) – L 12 (kHz)
High Cut Filter: H 20 (kHz) – H 60 (Hz)
The high and low cut filters are adjusted in 1 Hz increments; 10 Hz increments when over 1 kHz.

8. Channel Selector

(WM400-L and WM400-R only)
 Adjusting this dial to one of the preset channels allows the WM400 to know which pre-set frequency to look for the wireless information. The wireless transmitter should be set to the identical channel if transmission is to occur successfully.

9. On Indicator

(WM400-L and WM400-R only)
 This LED indicator illuminates when the WM400(D) receiver is powered.

10. Antenna

This is the WM400(D)'s antenna. Adjust it so it sits in a vertical position when the device is in use (change the position if the wireless signal quality is poor). Push the antenna in to release it before adjusting its position.

11. DC In and clip

Plug DC end of the supplied DC power adaptor (12V, 200mA) into this jack, and the other end into a suitable AC power source to allow the WM400(D) to be powered. The accompanying clip ensures the DC head of the power supply is kept securely in place.

12. XLR Output

This jack accepts XLR connectors to feed the signal from the Wireless Receiver to the Speaker.

13. Fixing

Use this hole to secure the WM400(D) receiver into the mounting socket of your speaker by use of the accompanying M6, M8 or M10 screws and a washer.

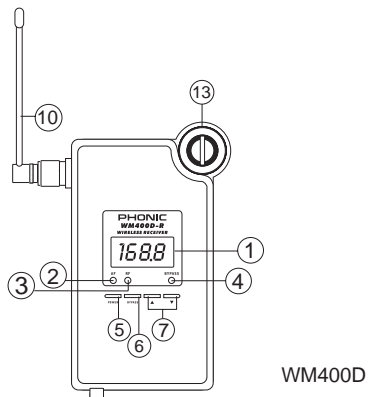
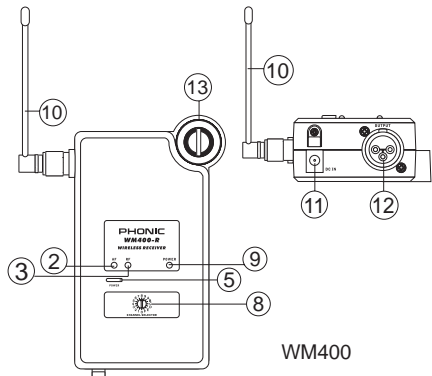

WM400(D) POWER MODES

Since some users will mount their WM400(D) with a speaker in a high position, Phonic thought it would be handy to make it so users could keep the power on constantly, as long as power is supplied to the unit and thus avoiding having to climb up high to push the power button. To make this adjustment, users are advised to follow the follow procedure:

1. Remove the two screws on the rear of the WM400(D) receiver and the antenna.
2. Remove the screw on the bottom of the WM400(D) beside the XLR output (the screw closer to the rear panel)
3. Remove the rear section of the casing by gripping the WM400(D) on both sides, squeezing and lifting up, in the process detaching the small clips within the casing.
4. A small switch should be visible on the PCB. Flick it to the left to ensure the power of the WM400(D) does not turn off without you pushing the power button.
5. Be sure to replace the casing and screws before using the WM400(D) receiver.

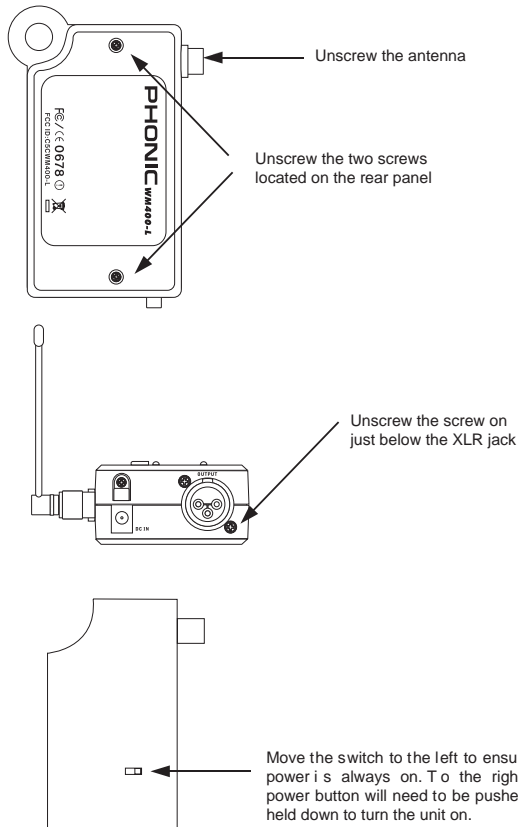

THE WM400D'S DIGITAL FEATURES

Channel Mode

The channel number of the WM400D will be displayed in the 4 digit display, unless adjustments are being made to other feature's properties. The channel number set should match that of the WM60 or WM70 transmitter to allow the wireless system to work successfully.

Delay Mode

Changing the delay allows audio engineers to compensate for the distance between speakers on stage and audience members at the rear of the venue. Using the delay effect on a speaker at the rear will ensure the audio from the stage reaches audience members at the rear at approximately the same time as the audio from the rear-speaker. The delay time is adjusted in 0.1 millisecond increments, between 0 and 300 milliseconds (holding the up or down button down speeds up the adjustment time)

EQ Mode

The different EQ modes allow users to adjust various frequencies of audio to enhance certain instruments, remove sibilance, feedback and other undesirable noises, and improve the overall fidelity of sounds. There are 30 presets to choose from (check EQ Preset page for more information), the titles of which describe what the effect does to your audio. The default setting, P0, is completely flat.

Low Cut Filter

A low cut filter allows users to cut low frequency sounds, ensuring stage rumble and other unwanted low-frequency sounds are removed from your audio. This can also help adjust the frequency to be more suitable for use with tweeters. The low cut filter's cut off frequency is adjusted in 1 Hz increments (10 Hz increments over 1kHz) between 10 Hz and 12 kHz. The default setting is 40 Hz.

High Cut Filter

The high cut filter allows users to remove unwanted high-frequency sounds, which can help to remove high frequency hiss and feedback, as well as make the audio signal more suitable for use with subwoofer speakers. The high cut filter's cut off frequency is adjusted in 1 Hz increments (10 Hz increments over 1kHz) between 20 kHz and 60 Hz. The default setting is 20 kHz.

ATTACHING THE UNIT TO A SPEAKER

Users can connect the WM400(D) Receiver modules to an active speaker using a mounting point or the included velcro strips, as indicated.

Mounting Point

Velcro Strip

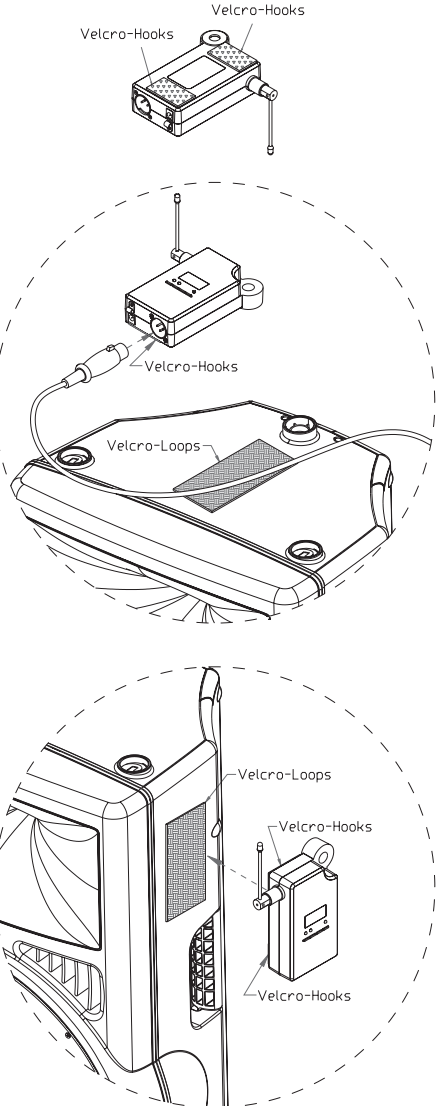
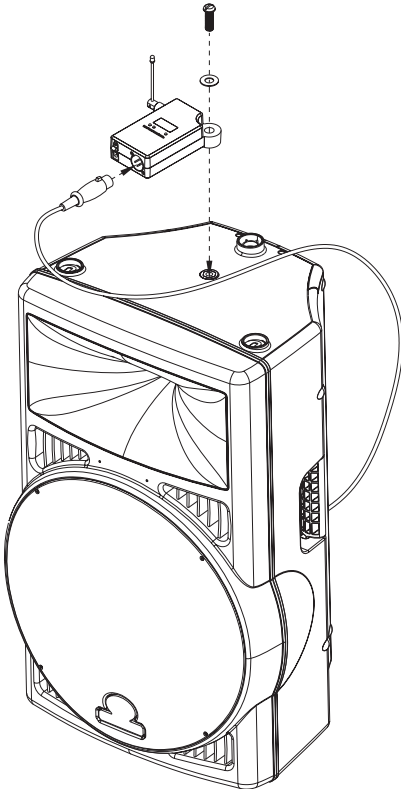

DIMENSIONS

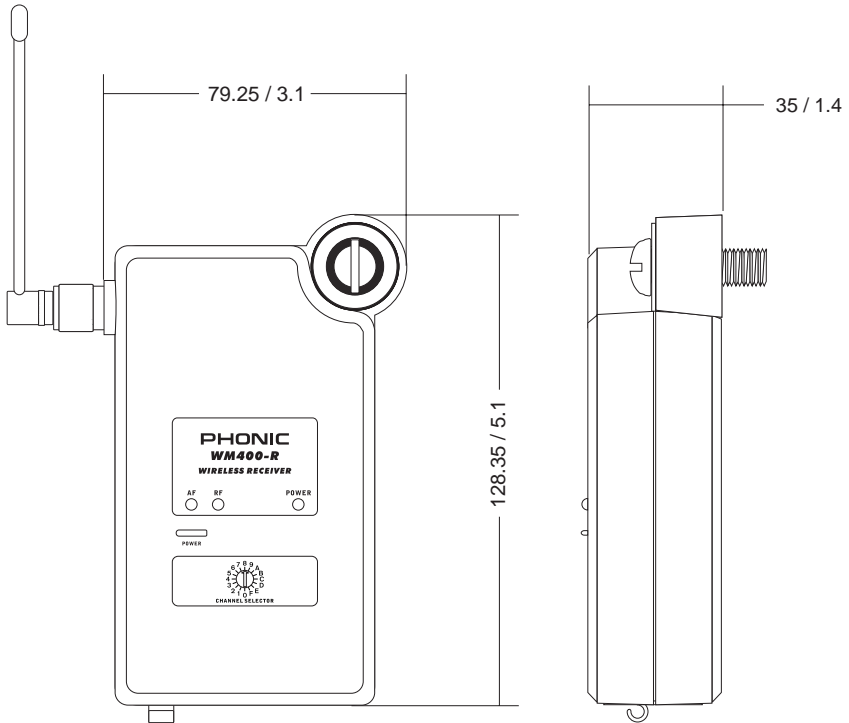

* All measurements are shown in mm/inches.

SPECIFICATIONS

WM400-L / WM400-R	
RF Sensitivity	-100 dBm
Image Rejection	75dB
T.H.D.	<0.5% @ 1KHz
LED indicator	Power On, RF, AF
Squelch	Pilot Tone & Noise Mute
Audio Output Connector	XLR
Output Impedance	200Ω
Power Requirement	12VDC external power supply (country dependent)
Overall Dimensions (WxHxD)	88.5 x 133 x 36.7 mm (3.5" x 5.2" x 1.4")
Net Weight	145 g (0.32 lbs)

WM400D-L / WM400D-R plus:	
Digital Delay	0.1 millisecond to 300.0 millisecond delay range, delay adjustment may be made with 0.1 millisecond precision
Extra features	30 preset EQ, Low-cut and High-cut filter
Display	4-digit display for delay time, frequency channel, EQ mode and Hi-cut/Lo-cut modes
Controls	power on/off, Digital processing bypass, up and down

EQ PRESETS

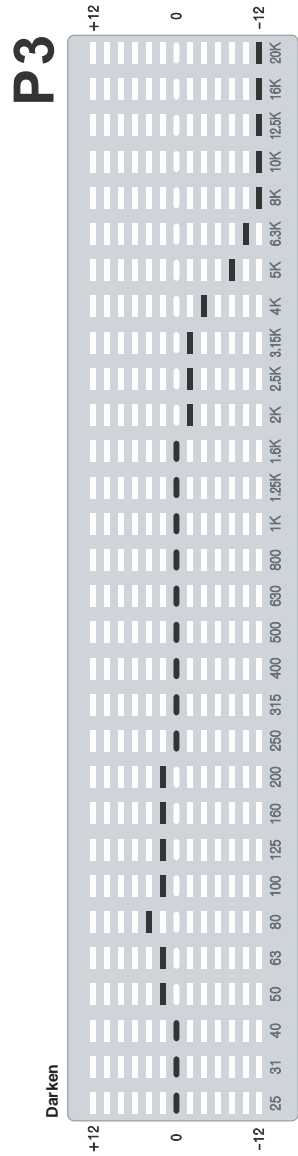
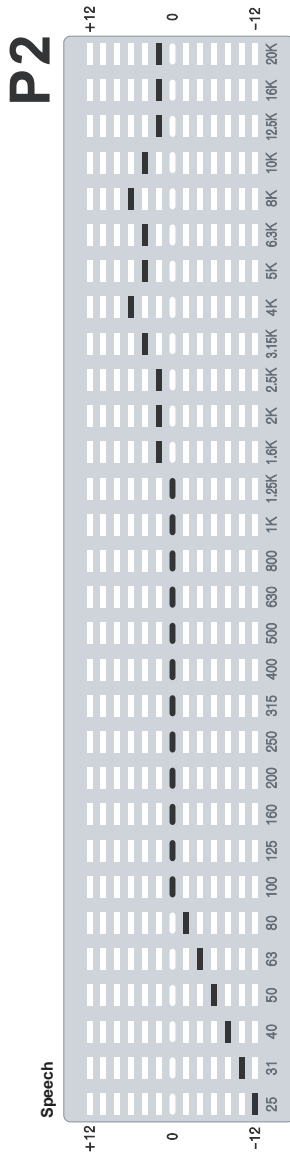
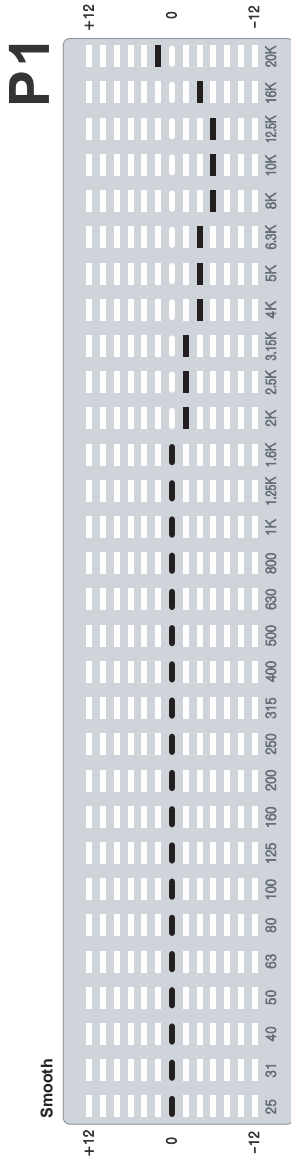

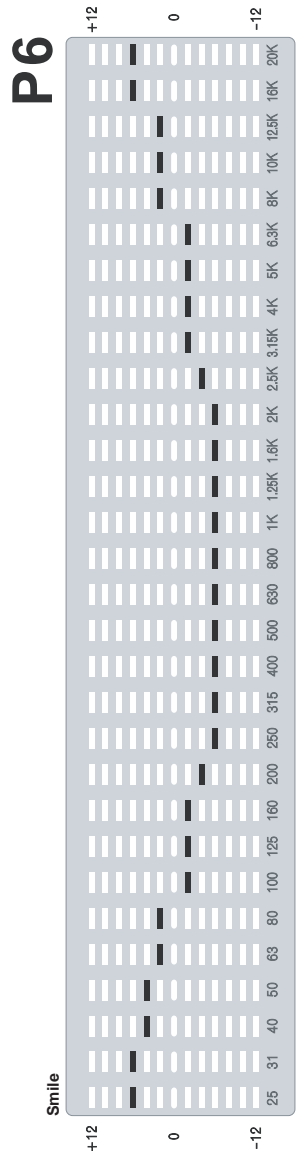
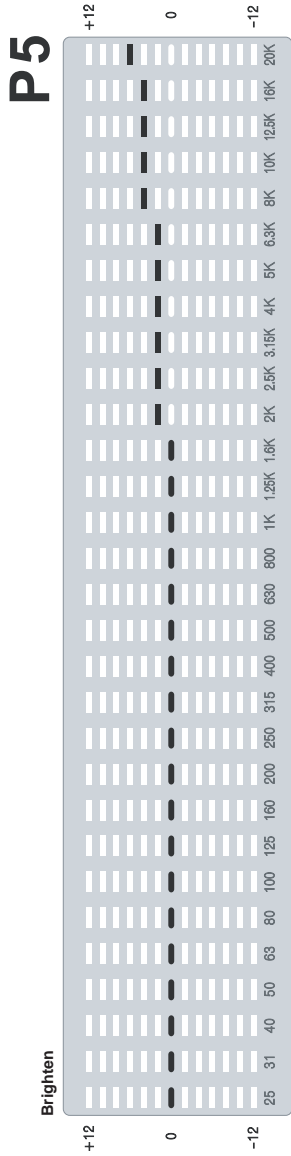
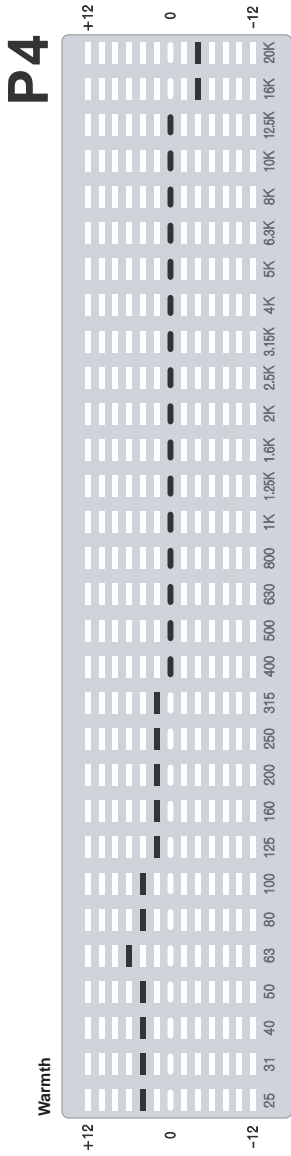

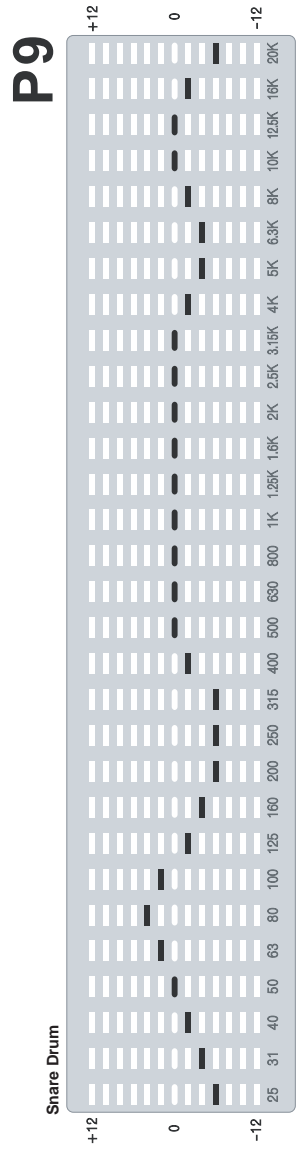
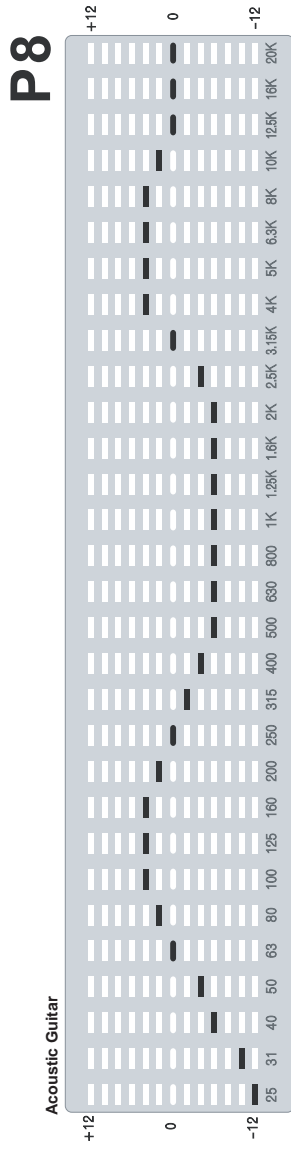
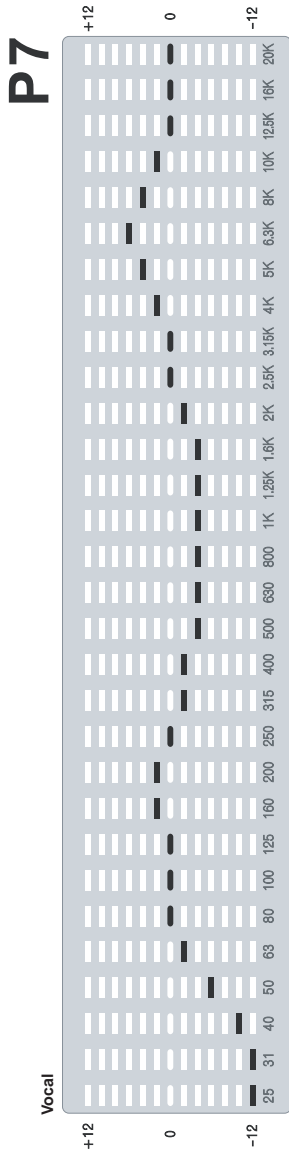

P10

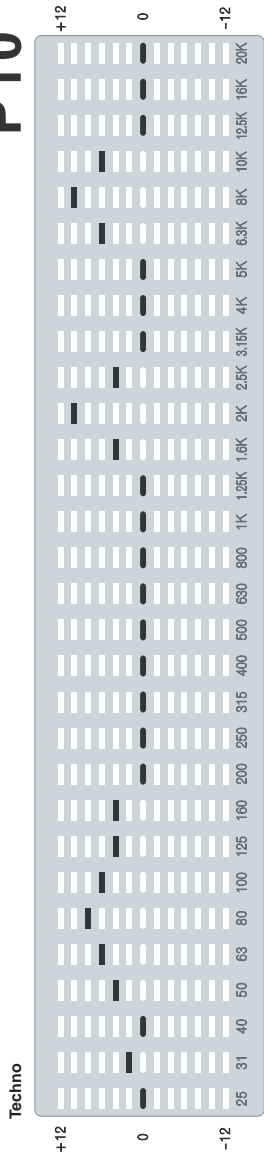

P11

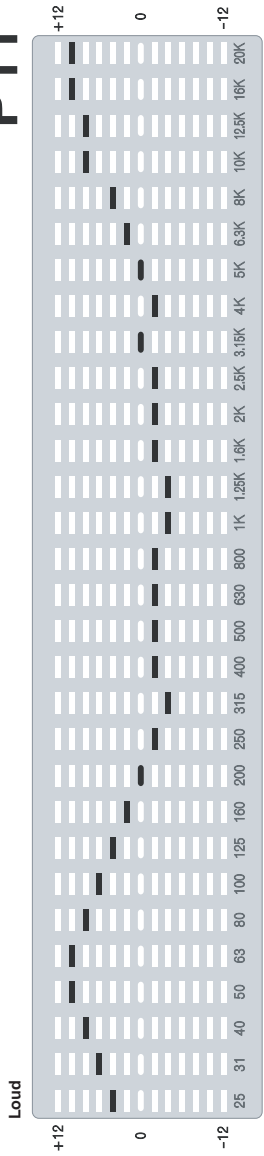

P12

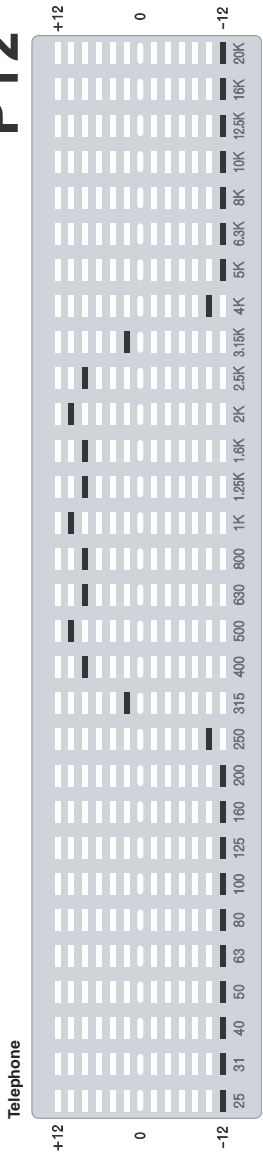

P13

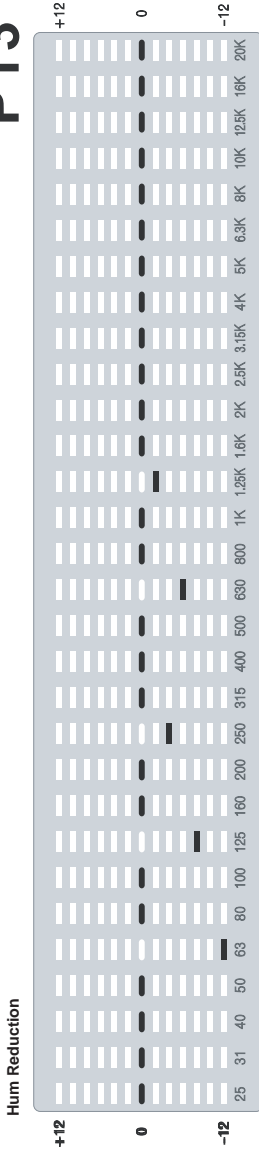

P14

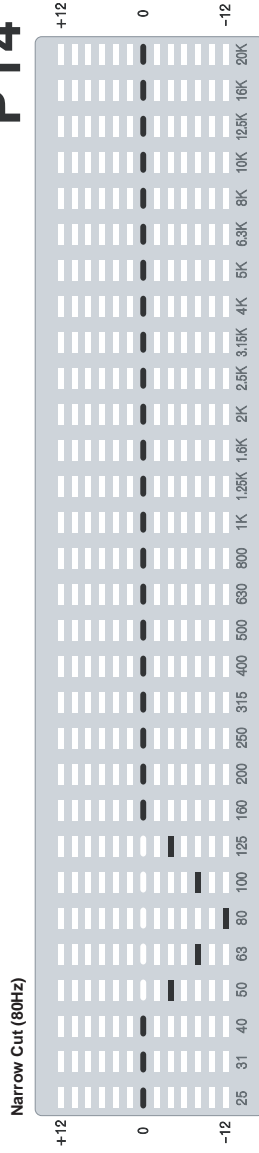

P15

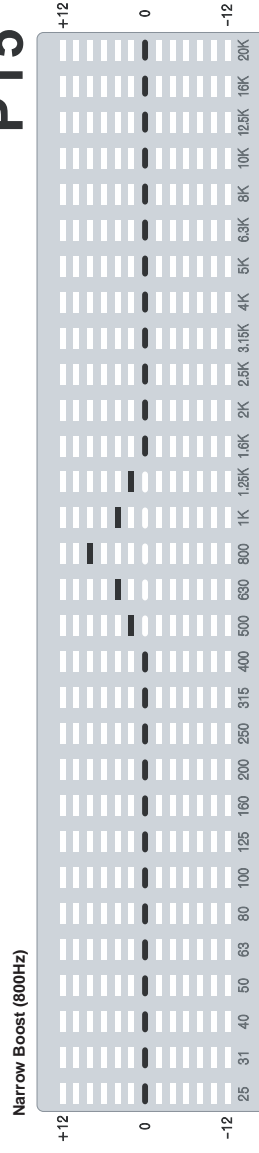

P16

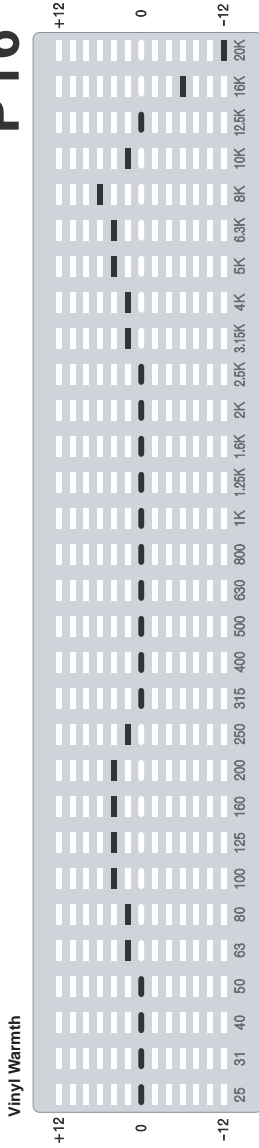

P17

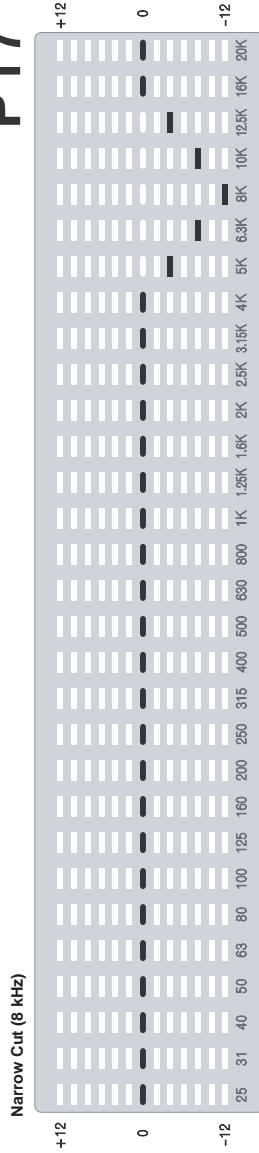

P18

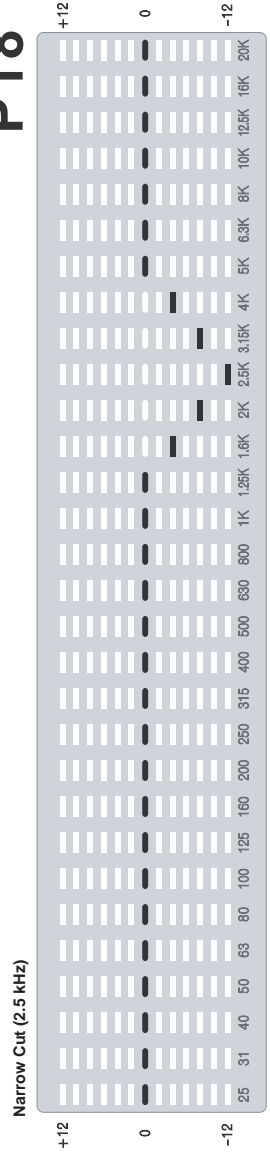

P19

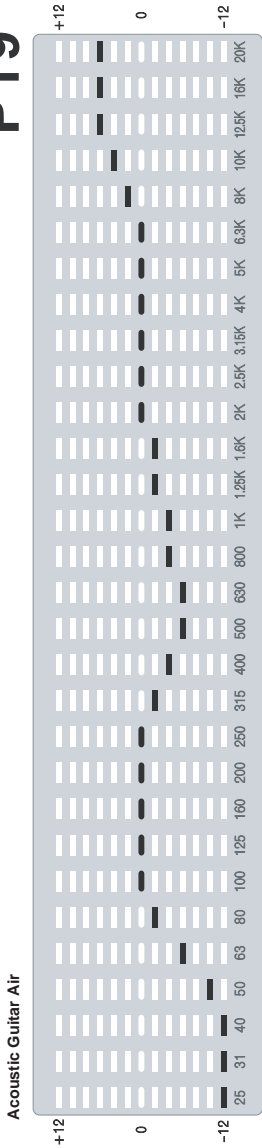

P20

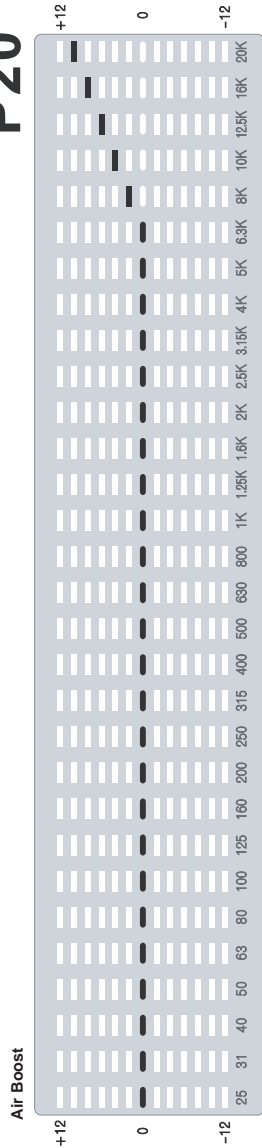

P21

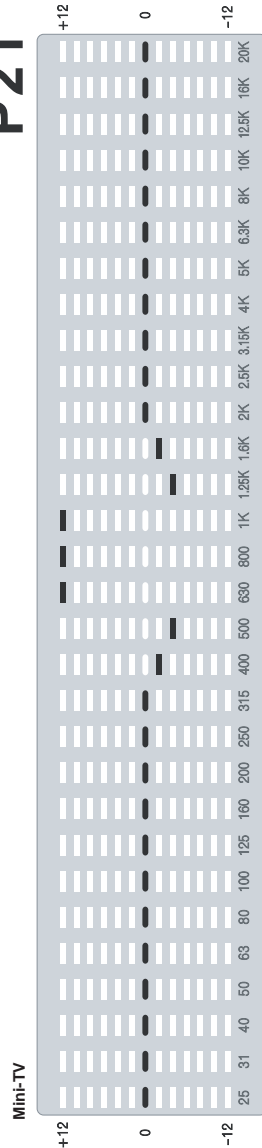

P22

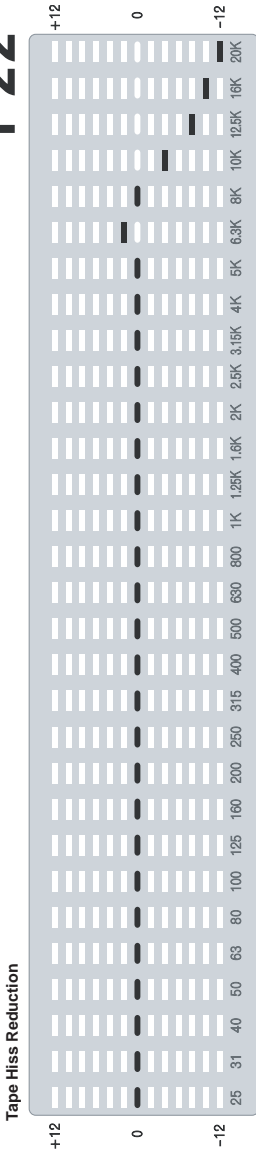

P23

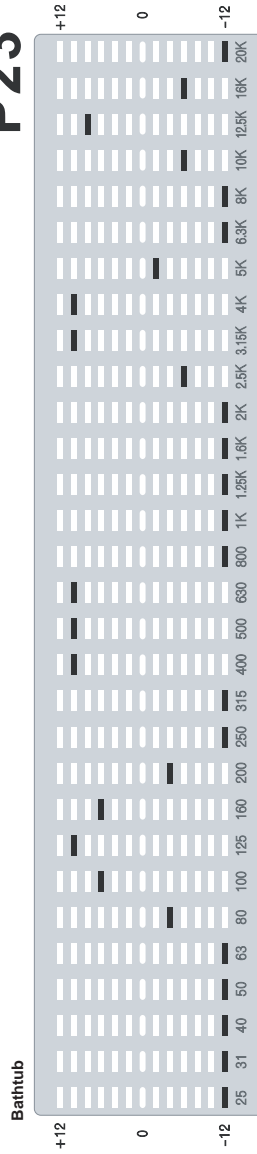

P24

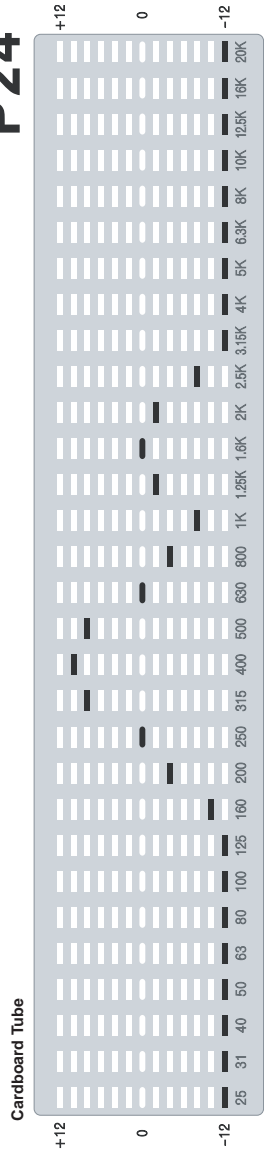

P25

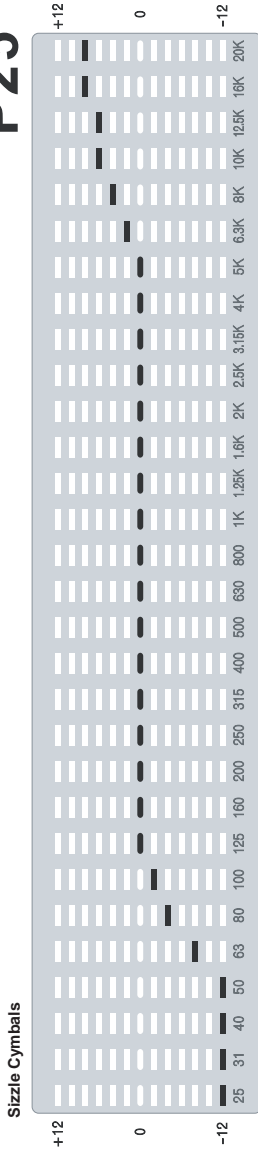

P26

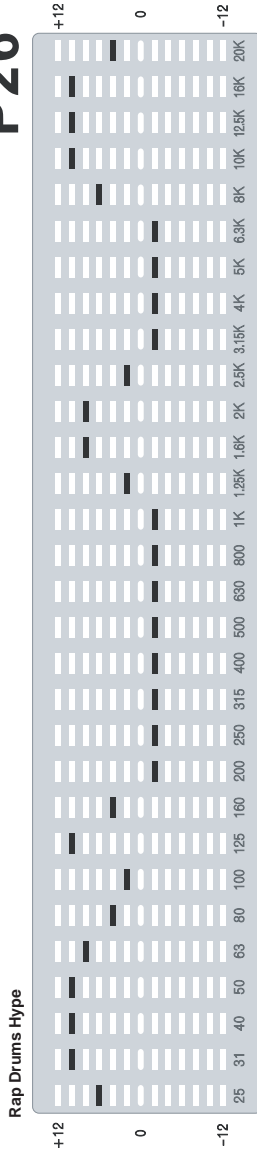

P27

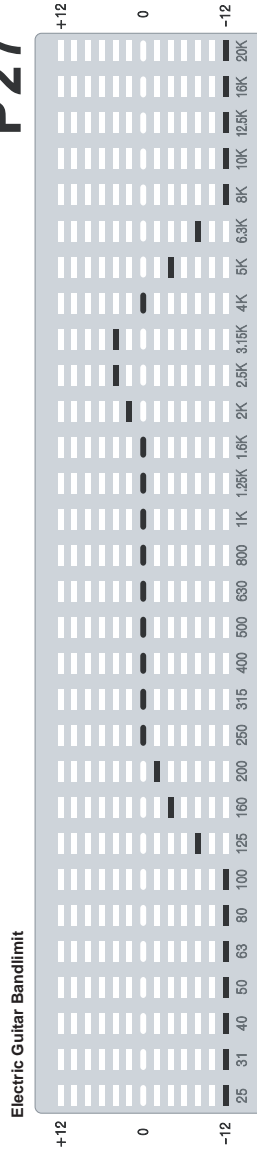

P28

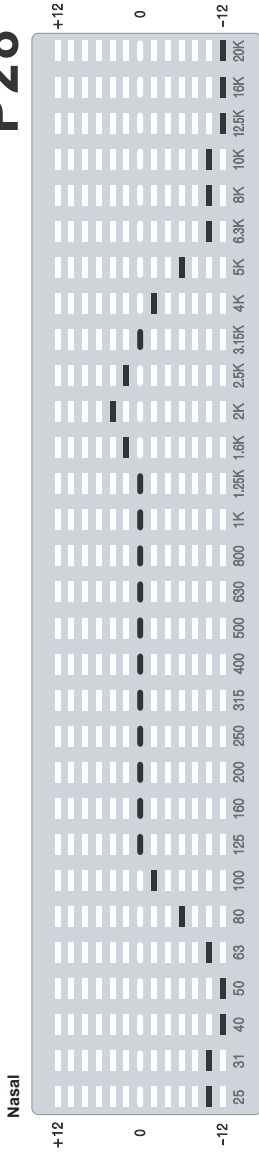

P29

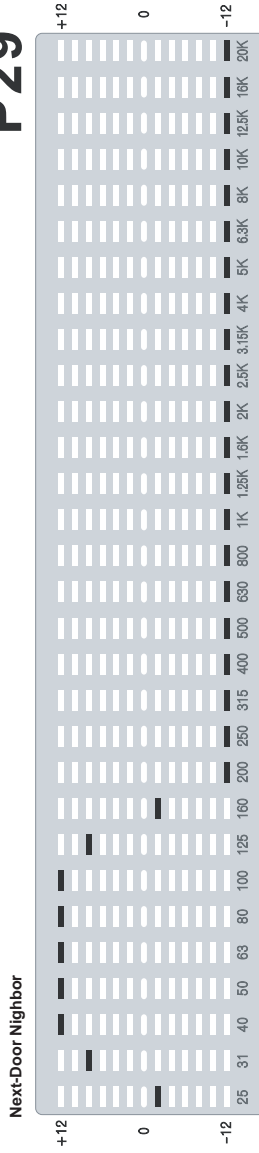

P30

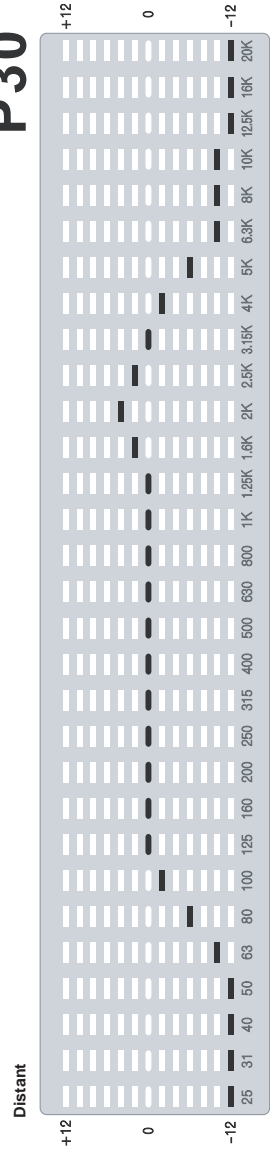

TO PURCHASE ADDITIONAL PHONIC GEAR AND ACCESSORIES

To purchase Phonic gear and optional accessories, contact any authorized Phonic distributor. For a list of Phonic distributors please visit our website at www.phonic.com and click on Get Gear. You may also contact Phonic directly and we will assist you in locating a distributor near you.

SERVICE AND REPAIR

For replacement parts, service and repairs please contact the Phonic distributor in your country. Phonic does not release service manuals to consumers, and advice users to not attempt any self repairs, as doing so voids all warranties. You can locate a dealer near you at <http://www.phonic.com/where/>.

WARRANTY INFORMATION

Phonic stands behind every product we make with a no-hassles warranty. Warranty coverage may be extended, depending on your region. Phonic Corporation warrants this product for a minimum of one year from the original date of purchase against defects in material and workmanship under use as instructed by the user's manual. Phonic, at its option, shall repair or replace the defective unit covered by this warranty. Please retain the dated sales receipt as evidence of the date of purchase. You will need it for any warranty service. No returns or repairs will be accepted without a proper RMA number (return merchandise authorization). In order to keep this warranty in effect, the product must have been handled and used as prescribed in the instructions accompanying this warranty. Any tempering of the product or attempts of self repair voids all warranty. This warranty does not cover any damage due to accident, misuse, abuse, or negligence. This warranty is valid only if the product was purchased new from an authorized Phonic dealer/distributor. For complete warranty policy information, please visit <http://www.phonic.com/warranty/>.

CUSTOMER SERVICE AND TECHNICAL SUPPORT

We encourage you to visit our online help at <http://www.phonic.com/support/>. There you can find answers to frequently asked questions, tech tips, driver downloads, returns instruction and other helpful information. We make every effort to answer your questions within one business day.

PHONIC

support@phonic.com <http://www.phonic.com>